



HAWK

Reach Beyond, with HAWK.

VISIT SITE NOW »



CAT 313 Excavator

VISIT SITE NOW »

www.hawkexcavator.com

| (619) 335 8822

| info@hawkexcavator.com



[VISIT SITE NOW >>](#)

TECHNICAL SPECIFICATIONS

Configurations and features may vary by region. Please consult CAT dealer for availability in your area.

Table of Contents

Specifications	2
Engine	2
Swing Mechanism	3
Weights	2
Track	3
Drive	3
Air Conditioning System.....	3
Hydraulic System	4
Service Refill Capacities	4
Standards	4
Sound Performance.....	4
Operating Weights and Ground Pressures	5
Major Component Weights	6
Dimensions	7
Working Ranges and Forces	8
Blade Working Ranges.....	9
Reach Boom Lift Capacities - Counterweight: 2.47 mt(5,445 lb)	10
Bucket Specifications and Compatibility	22
Attachments Offering Guide	24
Thumb Specifications.....	26
Standard and Optional Equipment	27
Dealer Installed Kits and Attachments	29
313 Environmental Declaration.....	30

[VISIT SITE NOW >>](#)



[VISIT SITE NOW >>](#)

SPECIFICATIONS

Engine

Engine Model	Cat® C3.6	
Net Power – ISO 9249	80.9 kW	108 hp
Net Power – ISO 9249 (DIN)	110 hp (metric)	
Engine Power – ISO 14396	82 kW	110 hp
Engine Power – ISO 14396 (DIN)	111 hp (metric)	
Bore	98 mm	4 in
Stroke	120 mm	5 in
Displacement	3.6 L	428 in ³
Biodiesel Capability	Up to B20 ⁽¹⁾	

- Meets U.S. EPA Tier 4 Final, EU Stage V, and Japan 2014 emission standards.
- No engine power derating required below 3000 m (9,840 ft) altitude.
- Advertised power is tested per the specified standard in effect at the time of manufacture.
- Net power advertised is the power available at the flywheel when the engine is equipped with fan, air intake system, exhaust system and alternator.
- Engine speed at 2,400 rpm.

⁽¹⁾Cat diesel engines are required to use ULSD (ultra-low sulfur diesel fuel with 15 ppm of sulfur or less) or ULSD blended with the following lower-carbon intensity fuels** up to:

- 20% biodiesel FAME (fatty acid methyl ester)*
- 100% renewable diesel, HVO (hydrotreated vegetable oil) and GTL (gas-to-liquid) fuels

Refer to guidelines for successful application. Please consult your Cat dealer or “Caterpillar Machine Fluids Recommendations” (SEBU6250) for details.

* Engines with no aftertreatment devices can use higher blends, up to 100% biodiesel (for use of blends higher than 20% biodiesel, consult your Cat dealer).

** Tailpipe greenhouse gas emissions from lower-carbon intensity fuels are essentially the same as traditional fuels.

[VISIT SITE NOW >>](#)



[VISIT SITE NOW >>](#)

Swing Mechanism

Swing Speed	11.5 rpm	
Maximum Swing Torque	35 kN·m	25,741 lbf-ft

Weights

Operating Weight	13,800 kg	30,400 lb
Triple Grouser Shoes		

- Long undercarriage, Reach boom, R3.0 (9'10") stick, GD 0.53 m³ (0.69 yd³) bucket, 700 mm (28") triple grouser shoes and 2470 kg (5,445 lb) counterweight.

Track

Optional Track Shoes Width	500 mm	20 in
Optional Track Shoes Width	600 mm	24 in
Optional Track Shoes Width	700 mm	28 in
Number of Shoes (each side)	46	
Number of Track Rollers (each side)	7	
Number of Carrier Rollers (each side)	2	

Drive

Gradeability	35°/70%	
Maximum Travel Speed	5.4 km/h	3.4 mph
Maximum Drawbar Pull - Long Undercarriage	114 kN	26,303 lbf

Air Conditioning System

The air conditioning system on this machine contains the fluorinated greenhouse gas refrigerant R134a (Global Warming Potential = 1430). The system contains 0.85 kg of refrigerant which has a CO₂ equivalent 1.216 metric tonne.

[VISIT SITE NOW >>](#)



VISIT SITE NOW »

Hydraulic System

Main System – Maximum Flow – Implement	247 L/min	65 gal/min
Maximum Pressure – Equipment – Normal	35 000 kPa	5,075 kPa
Maximum Pressure – Equipment – Lift Mode	38 000 kPa	5,075 kPa
Maximum Pressure – Travel	35 000 kPa	5,075 psi
Maximum Pressure – Swing	26 000 kPa	3,770 psi
Boom Cylinder – Bore	105 mm	4 in
Boom Cylinder – Stroke	1026 mm	40 in
Stick Cylinder – Bore	115 mm	5 in
Stick Cylinder – Stroke	1147 mm	45 in
Bucket Cylinder – Bore	95 mm	4 in
Bucket Cylinder – Stroke	939 mm	37 in

Service Refill Capacities

Fuel Tank Capacity	258 L	68.2 gal
Cooling System	15 L	4 gal
Engine Oil	8 L	2.1 gal
Final Drive (each)	3 L	0.8 gal
Hydraulic System (including tank)	85 L	22.5 gal
Hydraulic Tank	70 L	18.5 gal
DEF Tank	21 L	5.6 gal

Standards

Brakes	ISO 10265:2008
Cab/Rollover Protective Structure (ROPS)	ISO 12117-2:2008
Cab/Operator Protective Guards (OPG) (Optional)	ISO 10262-2:1998 Level II

Sound Performance

ISO 6395:2008 (external)	100 dB(A)
ISO 6396:2008 (inside cab)	68 dB(A)

- Hearing protection may be needed when operating with an open operator station and cab (when not properly maintained or doors/windows open) for extended periods or in a noisy environment

VISIT SITE NOW »



[VISIT SITE NOW >>](#)

Operating Weights and Ground Pressures

	500 mm (20") Triple Grouser Shoes		500 mm (20") TG Shoes with Rubber Pad		500 mm (20") Rubber Track Shoes	
	Weight	Ground Pressure	Weight	Ground Pressure	Weight	Ground Pressure
Base Machine Configurations	kg (lb)	kPa (psi)	kg (lb)	kPa (psi)	kg (lb)	kPa (psi)
Base Frame with Track Rollers and Carrier Rollers						
2470 kg (5,445 lb) Counterweight and Long Undercarriage Base Machine						
Reach Boom + R3.0 (9'10") Stick + 0.53 m ³ (0.69 yd ³) GD Bucket	13 300 (39,300)	39.7 (5.8)	13 800 (30,400)	41.2 (6.0)	13 500 (29,800)	40.3 (5.8)
Reach Boom + R3.0 (9'10") Stick + 0.53 m ³ (0.69 yd ³) GD Bucket + Blade	29 900 (65,800)	42.0 (6.1)	14 500 (32,000)	43.2 (6.3)	14 200 (31,300)	42.3 (6.1)

All operating weights include a 90% fuel tank with 75 kg (165 lb) operator.

	600 mm (24") Triple Grouser Shoes		600 mm (24") Rubber Track Shoes		700 mm (28") Triple Grouser Shoes	
	Weight	Ground Pressure	Weight	Ground Pressure	Weight	Ground Pressure
Base Machine Configurations	kg (lb)	kPa (psi)	kg (lb)	kPa (psi)	kg (lb)	kPa (psi)
Base Frame with Track Rollers and Carrier Rollers						
2470 kg (5,445 lb) Counterweight and Long Undercarriage Base Machine						
Reach Boom + R3.0 (9'10") Stick + 0.53 m ³ (0.69 yd ³) GD Bucket	13 600 (30,000)	33.8 (4.9)	13 800 (30,400)	34.3 (5.0)	13 800 (30,400)	29.4 (4.3)
Reach Boom + R3.0 (9'10") Stick + 0.53 m ³ (0.69 yd ³) GD Bucket + Blade	14 400 (31,700)	35.8 (5.2)	14 600 (32,200)	36.3 (5.3)	14 600 (32,200)	31.1 (4.5)

All operating weights include a 90% fuel tank with 75 kg (165 lb) operator.

[VISIT SITE NOW >>](#)



[VISIT SITE NOW >>](#)

Major Component Weights

	kg	lb
Base Machine Weight: including upper frame, undercarriage, counterweight, without boom, stick, bucket, boom cylinders, stick cylinder, bucket cylinders, tracks, blade, without 90% fuel tank, operator		
With Long Undercarriage	9150	20,200
With Long Undercarriage (blade compatible)	9450	20,800
Track Shoes:		
500 mm (20") Triple Grouser Track Shoes	1540	3,390
500 mm (20") Triple Grouser Track Shoes with Rubber Pad	1950	4,310
500 mm (20") Rubber Track Shoes	1670	3,680
600 mm (24") Triple Grouser Track Shoes	1810	4,000
600 mm (24") Rubber Track Shoes	1970	4,330
700 mm (28") Triple Grouser Track Shoes with Additional Steps	2020	4,440
Two Boom Cylinders	240	530
Weight of 90% Fuel Tank and 75 kg (165 lb) Operator	270	600
Blades (without lines, cylinders, frame modifications):		
2500 mm (8'2") Blade for use with 500 mm (20") Track Shoes	440	960
2600 mm (8'6") Blade for use with 600 mm (24") Track Shoes	490	1,080
2700 mm (8'10") Blade for use with 700 mm (28") Track Shoes	500	1,100
Counterweight:		
2470 kg (5,445 lb) Counterweight	2470	5,450
Swing Frame	1240	2,730
Undercarriage:		
Base Frame with Standard Track Rollers and Two Carrier Rollers	2690	5,930
Base Frame with Standard Track Rollers and Two Carrier Rollers (blade compatible)	2980	6,560
Boom (including lines, pins, stick cylinder):		
Reach Boom 4.65 m (15'3")	1030	2,270
Sticks (including lines, pins, bucket cylinder, bucket linkage):		
Reach Stick R2.8 (9'2")	650	1,400
Thumb Ready Stick R2.8 (9'2")	720	1,580
Reach Stick R3.0 (9'10")	650	1,440
Buckets (without linkage, with tips and side cutters):		
0.53 m ³ (0.69 yd ³) GD Bucket	440	970
0.53 m ³ (0.69 yd ³) SD Bucket	500	1,100
0.65 m ³ (0.85 yd ³) GD Bucket	470	1,030
0.65 m ³ (0.85 yd ³) SD Bucket	540	1,200
0.76 m ³ (0.99 yd ³) GD Bucket	510	1,120
Two Bucket Pins	20	50
Quick Coupler:		
Pin Grabber Quick Coupler	210	460

[VISIT SITE NOW >>](#)



VISIT SITE NOW >>

Dimensions

All dimensions are approximate and may vary depending on bucket selection

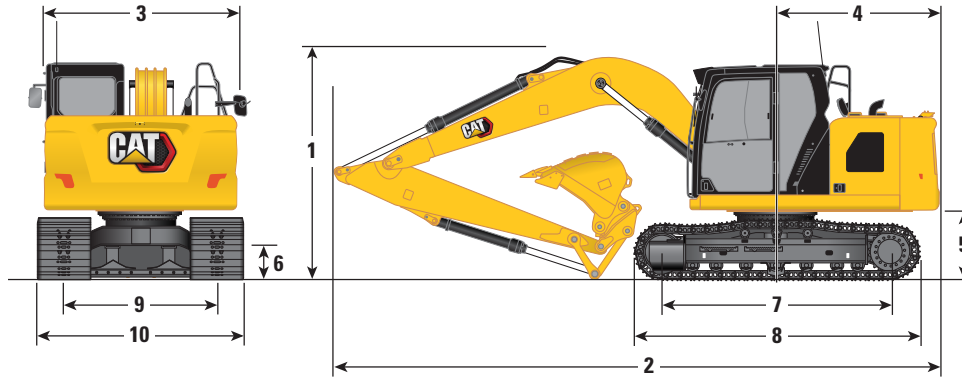

Boom Option	Reach Boom 4.65 m (15'3")			
	Thumb Ready/Reach Stick R2.8 (9'2")		Reach Stick R3.0 (9'10")	
Stick Options				
1 Machine Height: *				
Top of Cab Height	2810 mm	9'3"	2810 mm	9'3"
Top of OPG Height	2950 mm	9'8"	2950 mm	9'8"
Handrail Height	2810 mm	9'3"	2810 mm	9'3"
With Boom/Stick/Bucket Installed (with stick cylinder lines)	3070 mm	10'1"	3190 mm	10'6"
With Boom/Stick Installed (with stick cylinder lines)	3070 mm	10'1"	3190 mm	10'6"
With Boom Installed (with stick cylinder lines)	2370 mm	7'9"	2370 mm	7'9"
2 Machine Length (without blade):				
With Boom/Stick/Bucket Installed (with stick cylinder lines)	7790 mm	25'7"	7780 mm	25'6"
With Boom/Stick Installed (with stick cylinder lines)	7790 mm	25'7"	7780 mm	25'6"
With Boom Installed (with stick cylinder lines)	6890 mm	22'7"	6890 mm	22'7"
Machine Length (with blade, blade rear):				
With Boom/Stick/Bucket Installed (with stick cylinder lines)	8070 mm	26'6"	8050 mm	26'5"
With Boom/Stick Installed (with stick cylinder lines)	8070 mm	26'6"	8050 mm	26'5"
With Boom Installed (with stick cylinder lines)	7100 mm	23'4"	7100 mm	23'4"
3 Upperframe Width	2480 mm	8'2"	2480 mm	8'2"
4 Tail Swing Radius	2190 mm	7'2"	2190 mm	7'2"
5 Counterweight Clearance	915 mm	3'0"	915 mm	3'0"
6 Ground Clearance	445 mm	1'6"	445 mm	1'6"
7 Length to Center of Rollers	3040 mm	10'0"	3040 mm	10'0"
8 Track Length	3750 mm	12'4"	3750 mm	12'4"
9 Track Gauge	1990 mm	6'6"	1990 mm	6'6"
10 Track Width/Undercarriage Width:				
500 mm (20") Shoes	2490 mm	8'2"	2490 mm	8'2"
600 mm (24") Shoes	2590 mm	8'6"	2590 mm	8'6"
700 mm (28") Shoes (with steps)	2690 mm	8'10"	2690 mm	8'10"
Bucket Type	GD		GD	
Bucket Capacity	0.65 m ³	0.85 yd ³	0.53 m ³	0.69 yd ³
Bucket Tip Radius	1240 mm	4'1"	1240 mm	4'1"

*For models with rubber track shoes or rubber pad add 40 mm (16") to machine height dimensions

VISIT SITE NOW >>



VISIT SITE NOW »

Working Ranges and Forces

All dimensions are approximate and may vary depending on bucket selection

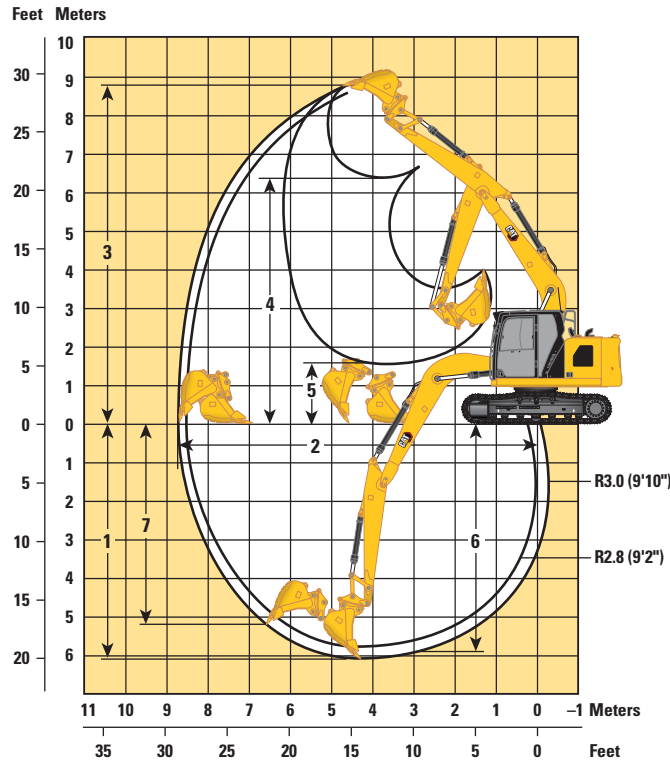

Boom Option	Reach Boom 4.65 m (15'3")			
	Thumb Ready/Reach Stick R2.8 (9'2")		Reach Stick R3.0 (9'10")	
1 Maximum Digging Depth	5840 mm	19'2"	6040 mm	19'10"
2 Maximum Reach at Ground Line	8470 mm	27'9"	8660 mm	28'5"
3 Maximum Cutting Height	8710 mm	28'7"	8830 mm	29'0"
4 Maximum Loading Height	6300 mm	20'8"	6420 mm	21'1"
5 Minimum Loading Height	1800 mm	5'11"	1600 mm	5'3"
6 Maximum Depth Cut for 2440 mm (8'0") Level Bottom	5650 mm	18'6"	5860 mm	19'3"
7 Vertical Wall Digging Depth	5000 mm	16'5"	5190 mm	17'0"
Minimum Working Equipment Radius	2540 mm	8'4"	2570 mm	8'5"
Bucket Digging Force (ISO)	98.67 kN	22,180 lbf	98.67 kN	22,180 lbf
Stick Digging Force (ISO)	62.34 kN	14,010 lbf	59.29 kN	13,330 lbf
Bucket Type	GD		GD	
Bucket Capacity	0.65 m ³	0.85 yd ³	0.53 m ³	0.69 yd ³
Bucket Tip Radius	1240 mm	4'1"	1240 mm	4'1"

VISIT SITE NOW »



[VISIT SITE NOW >>](#)

Blade Working Ranges

All dimensions are approximate and may vary depending on bucket selection

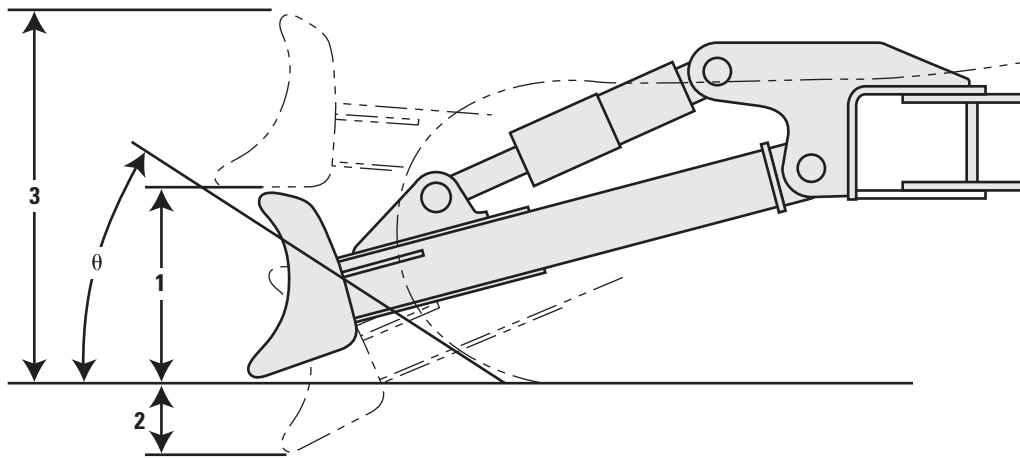

Blade Options	2500 mm (8'2")		2600 mm (8'6")		2700 mm (8'10")	
	1 Blade Height	616 mm	2'0"	616 mm	2'0"	616 mm
2 Maximum Lowering Depth from Ground	550 mm	1'10"	550 mm	1'10"	550 mm	1'10"
3 Maximum Raising Height above Ground	1018 mm	3'4"	1018 mm	3'4"	1018 mm	3'4"
θ Approach Angle	26°		26°		26°	

[VISIT SITE NOW >>](#)



VISIT SITE NOW >>

Reach Boom Lift Capacities – Counterweight: 2470 kg (5,445 lb) – without Bucket

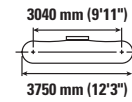
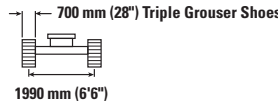
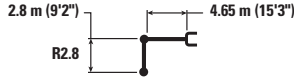

Reach (m/ft)	Unit	1.5 m/5.0 ft		3.0 m/10.0 ft		4.5 m/15.0 ft		6.0 m/20.0 ft		m/ft/in		
		kg/lb	kg/lb	kg/lb	kg/lb	kg/lb	kg/lb	kg/lb	kg/lb	kg/lb	kg/lb	
7.5 m 25.0 ft	kg lb									*2900	*2900	4.16
6.0 m 20.0 ft	kg lb									*2400 *5,250	*2400 *5,250	5.79 18'8"
4.5 m 15.0 ft	kg lb					*3500 *7,650	*3500 *7,650	*3500 *7,550	2550 5,500	*2250 *4,900	2100 4,700	6.71 21'10"
3.0 m 10.0 ft	kg lb			*5750 *12,350	*5750 *12,350	*4350 *9,450	3850 8,300	*3800 8,200	2500 5,350	*2250 *4,900	1850 4,050	7.21 23'7"
1.5 m 5.0 ft	kg lb			*8550 *18,400	6500 13,950	*5450 *11,750	3600 7,700	3700 7,900	2350 5,100	*2350 *5,150	1750 3,800	7.36 24'1"
0 m 0 ft	kg lb			*6950 *16,050	6050 13,050	5500 11,850	3400 7,250	3600 7,700	2250 4,850	*2600 *5,750	1750 3,850	7.20 23'7"
-1.5 m -5.0 ft	kg lb	*4500 *10,100	*4500 *10,100	*9450 *21,000	6000 12,850	5400 11,600	3300 7,050	3550 7,600	2250 4,750	3050 6,650	1950 4,250	6.71 21'11"
-3.0 m -10.0 ft	kg lb	*8000 *18,000	*8000 *18,000	*8600 *18,500	6050 13,000	5450 11,650	3300 7,100			3750 8,350	2400 5,250	5.78 18'9"
-4.5 m -15.0 ft	kg lb			*5900	*5900					*4050 *10,050	3950 *10,050	4.13 12'1"

Reach Boom Lift Capacities – Counterweight: 2470 kg (5,445 lb) – without Bucket

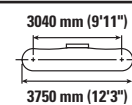
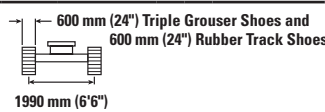

Reach (m/ft)	Unit	1.5 m/5.0 ft		3.0 m/10.0 ft		4.5 m/15.0 ft		6.0 m/20.0 ft		m/ft/in		
		kg/lb	kg/lb	kg/lb	kg/lb	kg/lb	kg/lb	kg/lb	kg/lb	kg/lb	kg/lb	
7.5 m 25.0 ft	kg lb									*2900	*2900	4.16
6.0 m 20.0 ft	kg lb									*2400 *5,250	*2400 *5,250	5.79 18'8"
4.5 m 15.0 ft	kg lb					*3500 *7,650	*3500 *7,650	*3500 *7,550	2550 5,400	*2250 *4,900	2100 4,600	6.71 21'10"
3.0 m 10.0 ft	kg lb			*5750 *12,350	*5750 *12,350	*4350 *9,450	3800 8,200	3750 8,100	2450 5,250	*2250 *4,900	1800 4,000	7.21 23'7"
1.5 m 5.0 ft	kg lb			*8550 *18,400	6400 13,750	*5450 *11,750	3550 7,600	3650 7,800	2350 5,000	*2350 *5,150	1700 3,750	7.36 24'1"
0 m 0 ft	kg lb			*6950 *16,050	6000 12,850	5450 11,700	3350 7,150	3550 7,600	2250 4,800	*2600 *5,750	1750 3,800	7.20 23'7"
-1.5 m -5.0 ft	kg lb	*4500 *10,100	*4500 *10,100	*9450 *21,000	5900 12,650	5350 11,450	3250 6,950	3500 7,450	2200 4,700	3000 6,550	1900 4,150	6.71 21'11"
-3.0 m -10.0 ft	kg lb	*8000 *18,000	*8000 *18,000	*8600 *18,500	6000 12,800	5350 11,500	3250 7,000			3700 8,250	2350 5,200	5.78 18'9"
-4.5 m -15.0 ft	kg lb			*5900	*5900					*4050 *10,050	3900 9,950	4.13 12'1"



ISO 10567:2007



* Indicates that the load is limited by hydraulic lifting capacity rather than tipping load. The above loads are in compliance with hydraulic excavator lift capacity standard ISO 10567:2007. They do not exceed 87% of hydraulic lifting capacity or 75% of tipping load. Weight of all lifting accessories must be deducted from the above lifting capacities. Lifting capacities are based on the machine standing on a firm, uniform supporting surface. The use of a work tool attachment point to handle/lift objects, could affect the machine lift performance.

Lift capacity stays with ±5% for all available track shoes.

Always refer to the appropriate Operation and Maintenance Manual for specific product information.

VISIT SITE NOW >>



VISIT SITE NOW >>

Reach Boom Lift Capacities – Counterweight: 2470 kg (5,445 lb) – without Bucket

2.8 m (9'2")
4.65 m (15'3")
R2.8

500 mm (20") Triple Grouser Shoes and
500 mm (20") Rubber Track Shoes

1990 mm (6'6")

3040 mm (9'11")
3750 mm (12'3")

			1.5 m/5.0 ft		3.0 m/10.0 ft		4.5 m/15.0 ft		6.0 m/20.0 ft				
7.5 m 25.0 ft	kg lb										*2900	*2900	4.16
6.0 m 20.0 ft	kg lb										*2400 *5,250	*2400 *5,250	5.79 18'8"
4.5 m 15.0 ft	kg lb					*3500 *7,650	*3500 *7,650	*3500 *7,550	2500 5,350		*2250 *4,900	2050 4,550	6.71 21'10"
3.0 m 10.0 ft	kg lb			*5750 *12,350	*5750 *12,350	*4350 *9,450	3750 8,050	3700 7,950	2400 5,150		*2250 *4,900	1800 3,950	7.21 23'7"
1.5 m 5.0 ft	kg lb			*8550 *18,400	6300 13,500	*5450 *11,750	3500 7,450	3550 7,650	2300 4,900		*2350 *5,150	1700 3,700	7.36 24'1"
0 m 0 ft	kg lb			*6950 *16,050	5900 12,600	5350 11,450	3250 7,000	3450 7,450	2200 4,700		*2600 *5,750	1700 3,700	7.20 23'7"
-1.5 m -5.0 ft	kg lb	*4500 *10,100	*4500 *10,100	*9450 *21,000	5800 12,400	5250 11,200	3200 6,800	3400 7,300	2150 4,600		2900 6,450	1850 4,100	6.71 21'11"
-3.0 m -10.0 ft	kg lb	*8000 *18,000	*8000 *18,000	*8600 *18,500	5850 12,600	5250 11,250	3200 6,850				3650 8,100	2300 5,100	5.78 18'9"
-4.5 m -15.0 ft	kg lb			*5900 *5900							*4050 *10,050	3800 9,750	4.13 12'11"

Reach Boom Lift Capacities – Counterweight: 2470 kg (5,445 lb) – without Bucket

2.8 m (9'2")
4.65 m (15'3")
R2.8

500 mm (20") Triple Grouser Shoes
with Rubber Pad

1990 mm (6'6")

3040 mm (9'11")
3750 mm (12'3")

			1.5 m/5.0 ft		3.0 m/10.0 ft		4.5 m/15.0 ft		6.0 m/20.0 ft				
7.5 m 25.0 ft	kg lb										*2900	*2900	4.16
6.0 m 20.0 ft	kg lb										*2400 *5,250	*2400 *5,250	5.79 18'8"
4.5 m 15.0 ft	kg lb					*3500 *7,650	*3500 *7,650	*3500 *7,550	2550 5,450		*2250 *4,900	2100 4,650	6.71 21'10"
3.0 m 10.0 ft	kg lb			*5750 *12,350	*5750 *12,350	*4350 *9,450	3850 8,250	*3800 8,150	2500 5,300		*2250 *4,900	1850 4,050	7.21 23'7"
1.5 m 5.0 ft	kg lb			*8550 *18,400	6450 13,900	*5450 *11,750	3550 7,700	3700 7,900	2350 5,050		*2350 *5,150	1750 3,800	7.36 24'1"
0 m 0 ft	kg lb			*6950 *16,050	6050 13,000	5500 11,800	3350 7,250	3550 7,650	2250 4,850		*2600 *5,750	1750 3,850	7.20 23'7"
-1.5 m -5.0 ft	kg lb	*4500 *10,100	*4500 *10,100	*9450 *21,000	5950 12,800	5400 11,550	3250 7,050	3500 7,550	2200 4,750		3000 6,650	1900 4,200	6.71 21'11"
-3.0 m -10.0 ft	kg lb	*8000 *18,000	*8000 *18,000	*8600 *18,500	6050 12,950	5400 11,600	3300 7,050				3750 8,350	2350 5,250	5.78 18'9"
-4.5 m -15.0 ft	kg lb			*5900 *5900							*4050 *10,050	3900 10,050	4.13 12'11"



ISO 10567:2007



* Indicates that the load is limited by hydraulic lifting capacity rather than tipping load. The above loads are in compliance with hydraulic excavator lift capacity standard ISO 10567:2007. They do not exceed 87% of hydraulic lifting capacity or 75% of tipping load. Weight of all lifting accessories must be deducted from the above lifting capacities. Lifting capacities are based on the machine standing on a firm, uniform supporting surface. The use of a work tool attachment point to handle/lift objects, could affect the machine lift performance.

Lift capacity stays with ±5% for all available track shoes.

Always refer to the appropriate Operation and Maintenance Manual for specific product information.

VISIT SITE NOW >>



VISIT SITE NOW >>

Reach Boom Lift Capacities – Counterweight: 2470 kg (5,445 lb) – without Bucket

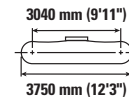
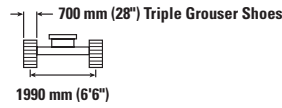
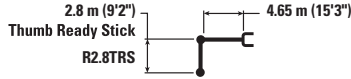

		1.5 m/5.0 ft		3.0 m/10.0 ft		4.5 m/15.0 ft		6.0 m/20.0 ft				m ft/in
7.5 m 25.0 ft	kg lb									*2850	*2850	4160
6.0 m 20.0 ft	kg lb									*2350 *5,200	*2350 *5,200	5.79 18'8"
4.5 m 15.0 ft	kg lb					*3500 *7,550	*3500 *7,550	*3450 *7,500	2550 5,400	*2200 *4,850	2100 4,600	6.71 21'10"
3.0 m 10.0 ft	kg lb			*5700 *12,200	*5700 *12,200	*4300 *9,350	3800 8,200	*3750 8,100	2450 5,250	*2200 *4,850	1800 4,000	7.21 23'7"
1.5 m 5.0 ft	kg lb			*8500 *18,250	6400 13,800	*5400 *11,600	3550 7,600	3650 7,850	2350 5,000	*2350 *5,100	1700 3,750	7.36 24'1"
0 m 0 ft	kg lb			*6900 *16,000	6000 12,850	5400 11,700	3350 7,150	3550 7,600	2250 4,750	*2600 *5,650	1700 3,750	7.20 23'7"
-1.5 m -5.0 ft	kg lb	*4500 *10,050	*4500 *10,050	*9400 *20,850	5900 12,650	5300 11,500	3250 6,950	3500 7,500	2200 4,650	3000 6,550	1900 4,150	6.71 21'11"
-3.0 m -10.0 ft	kg lb	*7950 *17,950	*7950 *17,950	*8500 *18,350	6000 12,850	5400 11,550	3250 7,000			3700 8,250	2350 5,150	5.78 18'9"
-4.5 m -15.0 ft	kg lb			*5850 *5850						*4000 *9,900	3900 *9,900	4.13 12'1"

Reach Boom Lift Capacities – Counterweight: 2470 kg (5,445 lb) – without Bucket

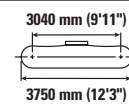
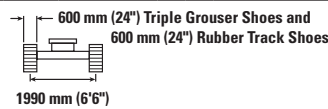

		1.5 m/5.0 ft		3.0 m/10.0 ft		4.5 m/15.0 ft		6.0 m/20.0 ft				m ft/in
7.5 m 25.0 ft	kg lb									*2850	*2850	4160
6.0 m 20.0 ft	kg lb									*2350 *5,200	*2350 *5,200	5.79 18'8"
4.5 m 15.0 ft	kg lb					*3500 *7,550	*3500 *7,550	*3450 *7,500	2500 5,350	*2200 *4,850	2050 4,550	6.71 21'10"
3.0 m 10.0 ft	kg lb			*5700 *12,200	*5700 *12,200	*4300 *9,350	3750 8,100	3750 8,000	2400 5,150	*2200 *4,850	1800 3,900	7.21 23'7"
1.5 m 5.0 ft	kg lb			*8500 *18,250	6350 13,600	*5400 *11,600	3500 7,500	3600 7,700	2300 4,900	*2350 *5,100	1700 3,650	7.36 24'1"
0 m 0 ft	kg lb			*6900 *16,000	5900 12,700	5400 11,550	3300 7,050	3500 7,500	2200 4,700	*2600 *5,650	1700 3,700	7.20 23'7"
-1.5 m -5.0 ft	kg lb	*4500 *10,050	*4500 *10,050	*9400 *20,850	5800 12,500	5300 11,300	3200 6,850	3450 7,350	2150 4,600	2950 6,450	1850 4,050	6.71 21'11"
-3.0 m -10.0 ft	kg lb	*7950 *17,950	*7950 *17,950	*8500 *18,350	5900 12,650	5300 11,400	3200 6,900			3650 8,150	2300 5,100	5.78 18'9"
-4.5 m -15.0 ft	kg lb			*5850 *5850						*4000 *9,900	3850 9,850	4.13 12'1"



ISO 10567:2007



* Indicates that the load is limited by hydraulic lifting capacity rather than tipping load. The above loads are in compliance with hydraulic excavator lift capacity standard ISO 10567:2007. They do not exceed 87% of hydraulic lifting capacity or 75% of tipping load. Weight of all lifting accessories must be deducted from the above lifting capacities. Lifting capacities are based on the machine standing on a firm, uniform supporting surface. The use of a work tool attachment point to handle/lift objects, could affect the machine lift performance.

Lift capacity stays with ±5% for all available track shoes.

Always refer to the appropriate Operation and Maintenance Manual for specific product information.

VISIT SITE NOW >>



VISIT SITE NOW >>

Reach Boom Lift Capacities – Counterweight: 2470 kg (5,445 lb) – without Bucket

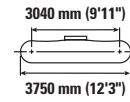
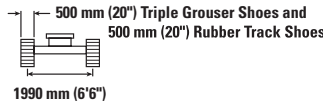
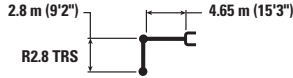

		1.5 m/5.0 ft		3.0 m/10.0 ft		4.5 m/15.0 ft		6.0 m/20.0 ft		m ft/in		
7.5 m 25.0 ft	kg lb									*2850	*2850	4.16
6.0 m 20.0 ft	kg lb									*2350 *5,200	*2350 *5,200	5.79 18'8"
4.5 m 15.0 ft	kg lb					*3500 *7,950	*3500 *7,950	*3450 2450	2450	*2200 *4,850	2000 4,450	6.71 21'10"
3.0 m 10.0 ft	kg lb			*5700 *12,200	*5700 *12,200	*4300 *9,350	3700 7,950	3650 7,850	2350 5,100	*2200 *4,850	1750 3,850	7.21 23'7"
1.5 m 5.0 ft	kg lb			*8500 *18,250	6200 13,350	*5400 *11,600	3450 7,350	3550 7,550	2250 4,850	*2350 *5,100	1650 3,600	7.36 24'1"
0 m 0 ft	kg lb			*6900 *16,000	5800 12,450	5300 11,350	3200 6,900	3400 7,350	2150 4,600	*2600 *5,650	1650 3,650	7.20 23'7"
-1.5 m -5.0 ft	kg lb	*4500 *10,050	*4500 *10,050	*9400 *20,850	5700 12,250	5150 11,100	3100 6,700	3350 7,200	2100 4,500	2900 6,350	1800 4,000	6.71 21'11"
-3.0 m -10.0 ft	kg lb	*7950 *17,950	*7950 *17,950	*8500 *18,350	5800 12,400	5200 11,150	3150 6,750			3600 8,000	2250 5,000	5.78 18'9"
-4.5 m -15.0 ft	kg lb			*5850 *5850						*4000 *9,900	3750 9,650	4.13 12'1"

Reach Boom Lift Capacities – Counterweight: 2470 kg (5,445 lb) – without Bucket

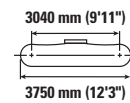
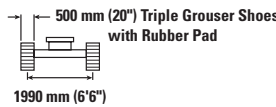
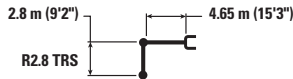

		1.5 m/5.0 ft		3.0 m/10.0 ft		4.5 m/15.0 ft		6.0 m/20.0 ft		m ft/in		
7.5 m 25.0 ft	kg lb									*2850	*2850	4.16
6.0 m 20.0 ft	kg lb									*2350 *5,200	*2350 *5,200	5.79 18'8"
4.5 m 15.0 ft	kg lb					*3500 *7,950	*3500 *7,950	*3450 2500	2500	*2200 *4,850	2050 4,600	6.71 21'10"
3.0 m 10.0 ft	kg lb			*5700 *12,200	*5700 *12,200	*4300 *9,350	3800 8,150	*3750 8,100	2450 5,200	*2200 *4,850	1800 3,950	7.21 23'7"
1.5 m 5.0 ft	kg lb			*8500 *18,250	6400 13,750	*5400 *11,600	3500 7,550	3650 7,800	2300 4,950	*2350 *5,100	1700 3,700	7.36 24'1"
0 m 0 ft	kg lb			*6900 *16,000	5950 12,800	5450 11,700	3300 7,100	3500 7,550	2200 4,750	*2600 *5,650	1700 3,750	7.20 23'7"
-1.5 m -5.0 ft	kg lb	*4500 *10,050	*4500 *10,050	*9400 *20,850	5900 12,600	5350 11,450	3200 6,900	3450 7,450	2150 4,650	2950 6,550	1900 4,100	6.71 21'11"
-3.0 m -10.0 ft	kg lb	*7950 *17,950	*7950 *17,950	*8500 *18,350	5950 12,800	5350 11,500	3250 6,950			3700 8,250	2300 5,150	5.78 18'9"
-4.5 m -15.0 ft	kg lb			*5850 *5850						*4000 *9,900	3850 9,900	4.13 12'1"



ISO 10567:2007



* Indicates that the load is limited by hydraulic lifting capacity rather than tipping load. The above loads are in compliance with hydraulic excavator lift capacity standard ISO 10567:2007. They do not exceed 87% of hydraulic lifting capacity or 75% of tipping load. Weight of all lifting accessories must be deducted from the above lifting capacities. Lifting capacities are based on the machine standing on a firm, uniform supporting surface. The use of a work tool attachment point to handle/lift objects, could affect the machine lift performance.

Lift capacity stays with ±5% for all available track shoes.

Always refer to the appropriate Operation and Maintenance Manual for specific product information.

VISIT SITE NOW >>



VISIT SITE NOW >>

Reach Boom Lift Capacities – Counterweight: 2470 kg (5,445 lb) – without Bucket

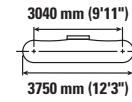
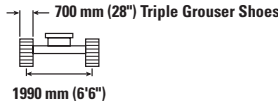
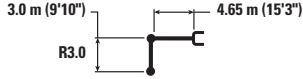

		1.5 m/5.0 ft		3.0 m/10.0 ft		4.5 m/15.0 ft		6.0 m/20.0 ft		7.5 m/25.0 ft		m ft/in		
7.5 m 25.0 ft	kg lb											*2600 *5,850	*2600 *5,850	4.49 14'1"
6.0 m 20.0 ft	kg lb							*2250 *2250				*2200 *4,850	*2200 *4,850	6.03 19'6"
4.5 m 15.0 ft	kg lb							*3350 *7,300	2600 5,550			*2050 *4,500	2050 4,500	6.92 22'6"
3.0 m 10.0 ft	kg lb			*5350 *11,450	*5350 *11,450	*4200 *9,050	3900 8,350	*3700 *8,000	2500 5,350			*2050 *4,500	1800 3,900	7.40 24'2"
1.5 m 5.0 ft	kg lb			*8200 *17,650	6550 14,100	*5300 *11,400	3600 7,750	3700 7,950	2400 5,100	*2400 1700		*2150 *4,750	1700 3,700	7.55 24'9"
0 m 0 ft	kg lb			*7250 *16,750	6100 13,100	5550 11,900	3400 7,300	3600 7,700	2300 4,900			*2400 *5,250	1700 3,700	7.40 24'3"
-1.5 m -5.0 ft	kg lb	*4350 *9,700	*4350 *9,700	*9200 *21,000	6000 12,800	5400 11,600	3300 7,050	3550 7,550	2200 4,750			*2850 *6,250	1850 4,050	6.91 22'7"
-3.0 m -10.0 ft	kg lb	*7450 *16,800	*7450 *16,800	*8800 *19,050	6050 12,950	5400 11,600	3300 7,050	3550 7,050	2250			3550 7,850	2250 4,950	6.02 19'7"
-4.5 m -15.0 ft	kg lb			*6400 *13,550	6250 13,450							*4000 *8,800	3450 7,900	4.48 14'4"

Reach Boom Lift Capacities – Counterweight: 2470 kg (5,445 lb) – without Bucket

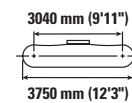
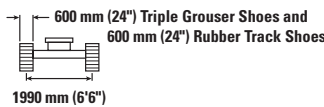

		1.5 m/5.0 ft		3.0 m/10.0 ft		4.5 m/15.0 ft		6.0 m/20.0 ft		7.5 m/25.0 ft		m ft/in		
7.5 m 25.0 ft	kg lb											*2600 *5,850	*2600 *5,850	4.49 14'1"
6.0 m 20.0 ft	kg lb							*2250 *2250				*2200 *4,850	*2200 *4,850	6.03 19'6"
4.5 m 15.0 ft	kg lb							*3350 *7,300	2550 5,450			*2050 *4,500	2000 4,400	6.92 22'6"
3.0 m 10.0 ft	kg lb			*5350 *11,450	*5350 *11,450	*4200 *9,050	3850 8,250	*3700 *8,000	2450 5,300			*2050 *4,500	1750 3,850	7.40 24'2"
1.5 m 5.0 ft	kg lb			*8200 *17,650	6500 13,950	*5300 *11,400	3550 7,650	3650 7,850	2350 5,050	*2400 1650		*2150 *4,750	1650 3,600	7.55 24'9"
0 m 0 ft	kg lb			*7250 *16,750	6000 12,900	5450 11,700	3350 7,200	3550 7,600	2250 4,800			*2400 *5,250	1650 3,650	7.40 24'3"
-1.5 m -5.0 ft	kg lb	*4350 *9,700	*4350 *9,700	*9200 *21,000	5900 12,650	5350 11,450	3250 6,950	3450 7,450	2200 4,700			*2850 *6,250	1800 4,000	6.91 22'7"
-3.0 m -10.0 ft	kg lb	*7450 *16,800	*7450 *16,800	*8800 *19,050	5950 12,750	5350 11,450	3250 6,950	3500	2200			3500 7,750	2200 4,900	6.02 19'7"
-4.5 m -15.0 ft	kg lb			*6400 *13,550	6150 13,250							*4000 *8,800	3450 7,800	4.48 14'4"



ISO 10567:2007



* Indicates that the load is limited by hydraulic lifting capacity rather than tipping load. The above loads are in compliance with hydraulic excavator lift capacity standard ISO 10567:2007. They do not exceed 87% of hydraulic lifting capacity or 75% of tipping load. Weight of all lifting accessories must be deducted from the above lifting capacities. Lifting capacities are based on the machine standing on a firm, uniform supporting surface. The use of a work tool attachment point to handle/lift objects, could affect the machine lift performance.

Lift capacity stays with ±5% for all available track shoes.

Always refer to the appropriate Operation and Maintenance Manual for specific product information.

VISIT SITE NOW >>



VISIT SITE NOW >>

Reach Boom Lift Capacities – Counterweight: 2470 kg (5,445 lb) – without Bucket

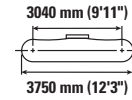
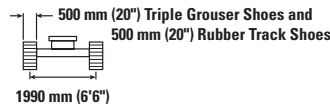
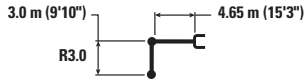

		1.5 m/5.0 ft		3.0 m/10.0 ft		4.5 m/15.0 ft		6.0 m/20.0 ft		7.5 m/25.0 ft		m ft/in		
7.5 m 25.0 ft	kg lb											*2600 *5,850	*2600 *5,850	4.49 14'1"
6.0 m 20.0 ft	kg lb							*2250 *2250	*2250 *2250			*2200 *4,850	*2200 *4,850	6.03 19'6"
4.5 m 15.0 ft	kg lb							*3350 *7,300	2500 5,350			*2050 *4,500	1950 4,350	6.92 22'6"
3.0 m 10.0 ft	kg lb			*5350 *11,450	*5350 *11,450	*4200 *9,050	3800 8,100	*3700 7,950	2450 5,200			*2050 *4,500	1700 3,750	7.40 24'2"
1.5 m 5.0 ft	kg lb			*8200 *17,650	6350 13,700	*5300 *11,400	3500 7,550	3600 7,700	2300 4,950	*2400 1650		*2150 *4,750	1600 3,550	7.55 24'9"
0 m 0 ft	kg lb			*7250 *16,750	5900 12,700	5350 11,500	3300 7,050	3450 7,450	2200 4,700			*2400 *5,250	1650 3,550	7.40 24'3"
-1.5 m -5.0 ft	kg lb	*4350 *9,700	*4350 *9,700	*9200 *21,000	5800 12,400	5250 11,200	3150 6,800	3400 7,300	2150 4,600			2800 6,150	1800 3,900	6.91 22'7"
-3.0 m -10.0 ft	kg lb	*7450 *16,800	*7450 *16,800	*8800 *19,050	5850 12,500	5250 11,250	3200 6,800	3450	2150			3400 7,600	2150 4,800	6.02 19'7"
-4.5 m -15.0 ft	kg lb			*6400 *13,550	6050 13,000							*4000 *8,800	3350 7,650	4.48 14'4"

Reach Boom Lift Capacities – Counterweight: 2470 kg (5,445 lb) – without Bucket

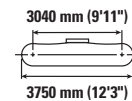
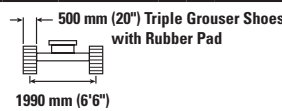

		1.5 m/5.0 ft		3.0 m/10.0 ft		4.5 m/15.0 ft		6.0 m/20.0 ft		7.5 m/25.0 ft		m ft/in		
7.5 m 25.0 ft	kg lb											*2600 *5,850	*2600 *5,850	4.49 14'1"
6.0 m 20.0 ft	kg lb							*2250 *2250	*2250 *2250			*2200 *4,850	*2200 *4,850	6.03 19'6"
4.5 m 15.0 ft	kg lb							*3350 *7,300	2600 5,500			*2050 *4,500	2000 4,450	6.92 22'6"
3.0 m 10.0 ft	kg lb			*5350 *11,450	*5350 *11,450	*4200 *9,050	3850 8,350	*3700 *8,000	2500 5,350			*2050 *4,500	1750 3,900	7.40 24'2"
1.5 m 5.0 ft	kg lb			*8200 *17,650	6550 14,050	*5300 *11,400	3600 7,750	3700 7,900	2350 5,100	*2400 1700		*2150 *4,750	1650 3,650	7.55 24'9"
0 m 0 ft	kg lb			*7250 *16,750	6100 13,050	5500 11,850	3400 7,250	3550 7,650	2250 4,850			*2400 *5,250	1700 3,700	7.40 24'3"
-1.5 m -5.0 ft	kg lb	*4350 *9,700	*4350 *9,700	*9200 *21,000	5950 12,750	5400 11,550	3250 7,000	3500 7,550	2200 4,750			*2850 *6,250	1850 4,000	6.91 22'7"
-3.0 m -10.0 ft	kg lb	*7450 *16,800	*7450 *16,800	*8800 *19,050	6000 12,900	5400 11,550	3250 7,050	3550	2250			3500 7,800	2250 4,950	6.02 19'7"
-4.5 m -15.0 ft	kg lb			*6400 *13,550	6250 13,400							*4000 *8,800	3450 7,850	4.48 14'4"



ISO 10567:2007



* Indicates that the load is limited by hydraulic lifting capacity rather than tipping load. The above loads are in compliance with hydraulic excavator lift capacity standard ISO 10567:2007. They do not exceed 87% of hydraulic lifting capacity or 75% of tipping load. Weight of all lifting accessories must be deducted from the above lifting capacities. Lifting capacities are based on the machine standing on a firm, uniform supporting surface. The use of a work tool attachment point to handle/lift objects, could affect the machine lift performance.

Lift capacity stays with ±5% for all available track shoes.

Always refer to the appropriate Operation and Maintenance Manual for specific product information.

VISIT SITE NOW >>



VISIT SITE NOW >>

Reach Boom Lift Capacities – Counterweight: 2470 kg (5,445 lb) – without Bucket – Blade Up

2700 mm (8'10") Blade

Reach	Unit	1.5 m/5.0 ft		3.0 m/10.0 ft		4.5 m/15.0 ft		6.0 m/20.0 ft		Blade		m ft/in
		kg	lb	kg	lb	kg	lb	kg	lb	kg	lb	
7.5 m 25.0 ft	kg									*2900	*2900	4.16
6.0 m 20.0 ft	kg									*2400	*2400	5.79
	lb									*5,250	*5,250	18'8"
4.5 m 15.0 ft	kg					*3500	*3500	*3500	2700	*2250	2250	6.71
	lb					*7,650	*7,650	*7,550	5,750	*4,900	*4,900	21'10"
3.0 m 10.0 ft	kg			*5750	*5750	*4350	4050	*3800	2600	*2250	1950	7.21
	lb			*12,350	*12,350	*9,450	8,700	*8,150	5,600	*4,900	4,300	23'7"
1.5 m 5.0 ft	kg			*8550	6800	*5450	3750	3700	2500	*2350	1850	7.36
	lb			*18,400	14,650	*11,750	8,100	7,900	5,350	*5,150	4,050	24'1"
0 m 0 ft	kg			*6950	6400	5500	3550	3550	2400	*2600	1850	7.20
	lb			*16,050	13,750	11,800	7,650	7,650	5,150	*5,750	4,100	23'7"
-1.5 m -5.0 ft	kg	*4500	*4500	*9450	6300	5400	3450	3500	2350	3000	2050	6.71
	lb	*10,100	*10,100	*21,000	13,550	11,550	7,450	7,550	5,050	6,650	4,450	21'11"
-3.0 m -10.0 ft	kg	*8000	*8000	*8600	6400	5400	3500			3750	2500	5.78
	lb	*18,000	*18,000	*18,500	13,700	11,600	7,500			8,300	5,550	18'9"
-4.5 m -15.0 ft	kg			*5900	*5900					*4050	*4050	4.13
	lb									*10,050	*10,050	12'1"

Reach Boom Lift Capacities – Counterweight: 2470 kg (5,445 lb) – without Bucket – Blade Up

2600 mm (8'6") Blade

Reach	Unit	1.5 m/5.0 ft		3.0 m/10.0 ft		4.5 m/15.0 ft		6.0 m/20.0 ft		Blade		m ft/in
		kg	lb	kg	lb	kg	lb	kg	lb	kg	lb	
7.5 m 25.0 ft	kg									*2900	*2900	4.16
6.0 m 20.0 ft	kg									*2400	*2400	5.79
	lb									*5,250	*5,250	18'8"
4.5 m 15.0 ft	kg					*3500	*3500	*3500	2650	*2250	2200	6.71
	lb					*7,650	*7,650	*7,550	5,700	*4,900	4,850	21'10"
3.0 m 10.0 ft	kg			*5750	*5750	*4350	4000	3750	2600	*2250	1900	7.21
	lb			*12,350	*12,350	*9,450	8,550	8,050	5,550	*4,900	4,250	23'7"
1.5 m 5.0 ft	kg			*8550	6700	*5450	3700	3650	2450	*2350	1800	7.36
	lb			*18,400	14,450	*11,750	8,000	7,800	5,300	*5,150	4,000	24'1"
0 m 0 ft	kg			*6950	6300	5400	3500	3500	2350	*2600	1850	7.20
	lb			*16,050	13,550	11,600	7,500	7,550	5,050	*5,750	4,000	23'7"
-1.5 m -5.0 ft	kg	*4500	*4500	*9450	6200	5300	3400	3450	2300	2950	2000	6.71
	lb	*10,100	*10,100	*21,000	13,350	11,400	7,350	7,450	4,950	6,550	4,400	21'11"
-3.0 m -10.0 ft	kg	*8000	*8000	*8600	6300	5350	3450			3700	2450	5.78
	lb	*18,000	*18,000	*18,500	13,500	11,450	7,400			8,200	5,500	18'9"
-4.5 m -15.0 ft	kg			*5900	*5900					*4050	*4050	4.13
	lb									*10,050	*10,050	12'1"



ISO 10567:2007



* Indicates that the load is limited by hydraulic lifting capacity rather than tipping load. The above loads are in compliance with hydraulic excavator lift capacity standard ISO 10567:2007. They do not exceed 87% of hydraulic lifting capacity or 75% of tipping load. Weight of all lifting accessories must be deducted from the above lifting capacities. Lifting capacities are based on the machine standing on a firm, uniform supporting surface. The use of a work tool attachment point to handle/lift objects, could affect the machine lift performance.

Lift capacity stays with ±5% for all available track shoes.

Always refer to the appropriate Operation and Maintenance Manual for specific product information.

VISIT SITE NOW >>



VISIT SITE NOW >>

Reach Boom Lift Capacities – Counterweight: 2470 kg (5,445 lb) – without Bucket – Blade Up

2500 mm (8'2") Blade

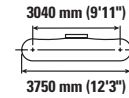
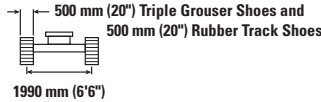
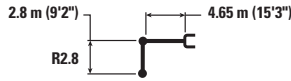

		1.5 m/5.0 ft		3.0 m/10.0 ft		4.5 m/15.0 ft		6.0 m/20.0 ft		m ft/in		
7.5 m 25.0 ft	kg lb									*2900 *2900	4.16	
6.0 m 20.0 ft	kg lb									*2400 *5,250	5.79 18'8"	
4.5 m 15.0 ft	kg lb					*3500 *7,650	*3500 *7,650	*3500 *7,550	2600 5,600	*2250 *4,900	2150 4,750	6.71 21'10"
3.0 m 10.0 ft	kg lb			*5750 *12,350	*5750 *12,350	*4350 *9,450	3900 8,400	3700 7,900	2550 5,400	*2250 *4,900	1900 4,150	7.21 23'7"
1.5 m 5.0 ft	kg lb			*8550 *18,400	6600 14,150	*5450 *11,750	3650 7,850	3550 7,650	2400 5,150	*2350 *5,150	1750 3,900	7.36 24'1"
0 m 0 ft	kg lb			*6950 *16,050	6150 13,250	5300 11,400	3450 7,400	3450 7,400	2300 4,950	*2600 *5,750	1800 3,900	7.20 23'7"
-1.5 m -5.0 ft	kg lb	*4500 *10,100	*4500 *10,100	*9450 *21,000	6100 13,050	5200 11,200	3350 7,200	3400 7,300	2250 4,850	2900 6,400	1950 4,300	6.71 21'11"
-3.0 m -10.0 ft	kg lb	*8000 *18,000	*8000 *18,000	*8600 *18,500	6150 13,200	5250 11,250	3350 7,200			3650 8,050	2400 5,350	5.78 18'9"
-4.5 m -15.0 ft	kg lb			*5900 *5900						*4050 *10,050	4000 *10,050	4.13 12'1"

Reach Boom Lift Capacities – Counterweight: 2470 kg (5,445 lb) – without Bucket – Blade Up

2500 mm (8'2") Blade

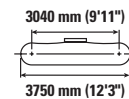
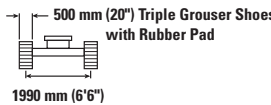

		1.5 m/5.0 ft		3.0 m/10.0 ft		4.5 m/15.0 ft		6.0 m/20.0 ft		m ft/in		
7.5 m 25.0 ft	kg lb									*2900 *2900	4.16	
6.0 m 20.0 ft	kg lb									*2400 *5,250	5.79 18'8"	
4.5 m 15.0 ft	kg lb					*3500 *7,650	*3500 *7,650	*3500 *7,550	2700 5,700	*2250 *4,900	2200 4,900	6.71 21'10"
3.0 m 10.0 ft	kg lb			*5750 *12,350	*5750 *12,350	*4350 *9,450	4000 8,600	3800 8,150	2600 5,550	*2250 *4,900	1950 4,250	7.21 23'7"
1.5 m 5.0 ft	kg lb			*8550 *18,400	6750 14,500	*5450 *11,750	3750 8,050	3650 7,850	2500 5,300	*2350 *5,150	1850 4,000	7.36 24'1"
0 m 0 ft	kg lb			*6950 *16,050	6350 13,600	5500 11,750	3550 7,600	3550 7,650	2400 5,100	*2600 *5,750	1850 4,050	7.20 23'7"
-1.5 m -5.0 ft	kg lb	*4500 *10,100	*4500 *10,100	*9450 *21,000	6250 13,400	5350 11,500	3450 7,400	3500 7,500	2350 5,000	3000 6,600	2000 4,450	6.71 21'11"
-3.0 m -10.0 ft	kg lb	*8000 *18,000	*8000 *18,000	*8600 *18,500	6350 13,600	5400 11,550	3450 7,450			3750 8,300	2500 5,500	5.78 18'9"
-4.5 m -15.0 ft	kg lb			*5900 *5900						*4050 *10,050	*4050 *10,050	4.13 12'1"



ISO 10567:2007



* Indicates that the load is limited by hydraulic lifting capacity rather than tipping load. The above loads are in compliance with hydraulic excavator lift capacity standard ISO 10567:2007. They do not exceed 87% of hydraulic lifting capacity or 75% of tipping load. Weight of all lifting accessories must be deducted from the above lifting capacities. Lifting capacities are based on the machine standing on a firm, uniform supporting surface. The use of a work tool attachment point to handle/lift objects, could affect the machine lift performance.

Lift capacity stays with ±5% for all available track shoes.

Always refer to the appropriate Operation and Maintenance Manual for specific product information.

VISIT SITE NOW >>









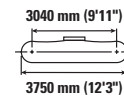
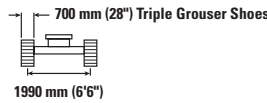
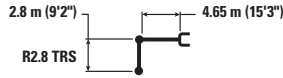



VISIT SITE NOW >>

Reach Boom Lift Capacities – Counterweight: 2470 kg (5,445 lb) – without Bucket – Blade Up

2700 mm (8'10") Blade









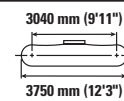
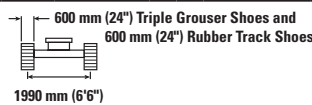



		1.5 m/5.0 ft		3.0 m/10.0 ft		4.5 m/15.0 ft		6.0 m/20.0 ft				m ft/in
												
7.5 m 25.0 ft	kg lb									*2850	*2850	4.16
6.0 m 20.0 ft	kg lb									*2350 *5,200	*2350 *5,200	5.79 18'8"
4.5 m 15.0 ft	kg lb					*3500 *7,550	*3500 *7,550	*3450 *7,500	2650 5,700	*2200 *4,850	2200 4,850	6.71 21'10"
3.0 m 10.0 ft	kg lb			*5700 *12,200	*5700 *12,200	*4300 *9,350	4000 8,600	*3750 8,050	2600 5,500	*2200 *4,850	1900 4,200	7.21 23'7"
1.5 m 5.0 ft	kg lb			*8500 *18,250	6750 14,500	*5400 *11,600	3700 8,000	3650 7,800	2450 5,250	*2350 *5,100	1800 3,950	7.36 24'1"
0 m 0 ft	kg lb			*6900 *16,000	6300 13,550	5450 11,650	3500 7,550	3500 7,550	2350 5,050	*2600 *5,650	1800 4,000	7.20 23'7"
-1.5 m -5.0 ft	kg lb	*4500 *10,050	*4500 *10,050	*9400 *20,850	6250 13,350	5350 11,450	3400 7,350	3450 7,450	2300 4,950	2950 6,550	2000 4,400	6.71 21'11"
-3.0 m -10.0 ft	kg lb	*7950 *17,950	*7950 *17,950	*8500 *18,350	6300 13,550	5350 11,500	3450 7,400			3700 8,250	2450 5,450	5.78 18'9"
-4.5 m -15.0 ft	kg lb			*5850 *5850	*5850					*4000 *9,900	*4000 *9,900	4.13 12'1"

Reach Boom Lift Capacities – Counterweight: 2470 kg (5,445 lb) – without Bucket – Blade Up

2600 mm (8'6") Blade



		1.5 m/5.0 ft		3.0 m/10.0 ft		4.5 m/15.0 ft		6.0 m/20.0 ft				m ft/in
												
7.5 m 25.0 ft	kg lb									*2850	*2850	4.16
6.0 m 20.0 ft	kg lb									*2350 *5,200	*2350 *5,200	5.79 18'8"
4.5 m 15.0 ft	kg lb					*3500 *7,550	*3500 *7,550	*3450 *7,500	2650 5,600	*2200 *4,850	2150 4,800	6.71 21'10"
3.0 m 10.0 ft	kg lb			*5700 *12,200	*5700 *12,200	*4300 *9,350	3950 8,500	3700 7,950	2550 5,450	*2200 *4,850	1900 4,150	7.21 23'7"
1.5 m 5.0 ft	kg lb			*8500 *18,250	6650 14,300	*5400 *11,600	3650 7,900	3600 7,700	2400 5,200	*2350 *5,100	1800 3,900	7.36 24'1"
0 m 0 ft	kg lb			*6900 *16,000	6250 13,350	5350 11,500	3450 7,450	3450 7,450	2300 4,950	*2600 *5,650	1800 3,950	7.20 23'7"
-1.5 m -5.0 ft	kg lb	*4500 *10,050	*4500 *10,050	*9400 *20,850	6150 13,150	5250 11,250	3350 7,200	3400 7,350	2250 4,850	2950 6,450	1950 4,300	6.71 21'11"
-3.0 m -10.0 ft	kg lb	*7950 *17,950	*7950 *17,950	*8500 *18,350	6200 13,350	5300 11,350	3400 7,250			3650 8,100	2450 5,400	5.78 18'9"
-4.5 m -15.0 ft	kg lb			*5850 *5850	*5850					*4000 *9,900	*4000 *9,900	4.13 12'1"



ISO 10567:2007



* Indicates that the load is limited by hydraulic lifting capacity rather than tipping load. The above loads are in compliance with hydraulic excavator lift capacity standard ISO 10567:2007. They do not exceed 87% of hydraulic lifting capacity or 75% of tipping load. Weight of all lifting accessories must be deducted from the above lifting capacities. Lifting capacities are based on the machine standing on a firm, uniform supporting surface. The use of a work tool attachment point to handle/lift objects, could affect the machine lift performance.

Lift capacity stays with ±5% for all available track shoes.

Always refer to the appropriate Operation and Maintenance Manual for specific product information.

VISIT SITE NOW >>



VISIT SITE NOW >>

Reach Boom Lift Capacities – Counterweight: 2470 kg (5,445 lb) – without Bucket – Blade Up

2500 mm (8'2") Blade

		1.5 m/5.0 ft		3.0 m/10.0 ft		4.5 m/15.0 ft		6.0 m/20.0 ft		 m ft/in		
7.5 m 25.0 ft	kg lb									*2850	*2850	4.16
6.0 m 20.0 ft	kg lb									*2350 *5,200	*2350 *5,200	5.79 18'8"
4.5 m 15.0 ft	kg lb					*3500 *7,550	*3500 *7,550	*3450 *7,500	2550 5,500	*2200 *4,850	2100 4,700	6.71 21'10"
3.0 m 10.0 ft	kg lb			*5700 *12,200	*5700 *12,200	*4300 *9,350	3850 8,300	3650 7,800	2500 5,350	*2200 *4,850	1850 4,050	7.21 23'7"
1.5 m 5.0 ft	kg lb			*8500 *18,250	6500 14,000	*5400 *11,600	3600 7,750	3500 7,550	2350 5,100	*2350 *5,100	1750 3,800	7.36 24'1"
0 m 0 ft	kg lb			*6900 *16,000	6100 13,050	5250 11,300	3400 7,250	3400 7,300	2250 4,850	2600 5,650	1750 3,850	7.20 23'7"
-1.5 m -5.0 ft	kg lb	*4500 *10,050	*4500 *10,050	*9400 *20,850	6000 12,900	5150 11,050	3300 7,050	3350 7,200	2200 4,750	2850 6,300	1900 4,200	6.71 21'11"
-3.0 m -10.0 ft	kg lb	*7950 *17,950	*7950 *17,950	*8500 *18,350	6100 13,050	5200 11,100	3300 7,100			3600 7,950	2350 5,250	5.78 18'9"
-4.5 m -15.0 ft	kg lb			*5850 *5850	*5850					*4000 *9,900	3950 *9,900	4.13 12'1"

Reach Boom Lift Capacities – Counterweight: 2470 kg (5,445 lb) – without Bucket – Blade Up

2500 mm (8'2") Blade

		1.5 m/5.0 ft		3.0 m/10.0 ft		4.5 m/15.0 ft		6.0 m/20.0 ft		 m ft/in		
7.5 m 25.0 ft	kg lb									*2850	*2850	4.16
6.0 m 20.0 ft	kg lb									*2350 *5,200	*2350 *5,200	5.79 18'8"
4.5 m 15.0 ft	kg lb					*3500 *7,550	*3500 *7,550	*3450 *7,500	2650 5,650	*2200 *4,850	2150 4,800	6.71 21'10"
3.0 m 10.0 ft	kg lb			*5700 *12,200	*5700 *12,200	*4300 *9,350	3950 8,550	*3750 8,050	2550 5,450	*2200 *4,850	1900 4,150	7.21 23'7"
1.5 m 5.0 ft	kg lb			*8500 *18,250	6700 14,350	*5400 *11,600	3700 7,950	3650 7,800	2450 5,200	*2350 *5,100	1800 3,900	7.36 24'1"
0 m 0 ft	kg lb			*6900 *16,000	6250 13,450	5400 11,650	3500 7,450	3500 7,550	2350 5,000	*2600 *5,650	1800 3,950	7.20 23'7"
-1.5 m -5.0 ft	kg lb	*4500 *10,050	*4500 *10,050	*9400 *20,850	6200 13,250	5300 11,400	3400 7,250	3450 7,450	2300 4,900	2950 6,500	2000 4,350	6.71 21'11"
-3.0 m -10.0 ft	kg lb	*7950 *17,950	*7950 *17,950	*8500 *18,350	6250 13,400	5350 11,450	3400 7,300			3700 8,200	2450 5,400	5.78 18'9"
-4.5 m -15.0 ft	kg lb			*5850 *5850	*5850					*4000 *9,900	*4000 *9,900	4.13 12'1"



ISO 10567:2007



* Indicates that the load is limited by hydraulic lifting capacity rather than tipping load. The above loads are in compliance with hydraulic excavator lift capacity standard ISO 10567:2007. They do not exceed 87% of hydraulic lifting capacity or 75% of tipping load. Weight of all lifting accessories must be deducted from the above lifting capacities. Lifting capacities are based on the machine standing on a firm, uniform supporting surface. The use of a work tool attachment point to handle/lift objects, could affect the machine lift performance.

Lift capacity stays with ±5% for all available track shoes.

Always refer to the appropriate Operation and Maintenance Manual for specific product information.

VISIT SITE NOW >>



VISIT SITE NOW >>

Reach Boom Lift Capacities – Counterweight: 2470 kg (5,445 lb) – without Bucket – Blade Up

2700 mm (8'10") Blade

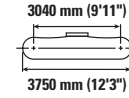
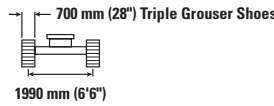
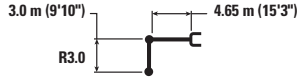

		1.5 m/5.0 ft		3.0 m/10.0 ft		4.5 m/15.0 ft		6.0 m/20.0 ft		7.5 m/25.0 ft				
7.5 m 25.0 ft	kg lb											*2600 *5,850	*2600 *5,850	m ft/in
6.0 m 20.0 ft	kg lb							*2250 *2250	*2250 *2250			*2200 *4,850	*2200 *4,850	6.03 19'6"
4.5 m 15.0 ft	kg lb							*3350 *7,300	2700 5,800			*2050 *4,500	*2050 *4,500	6.92 22'6"
3.0 m 10.0 ft	kg lb			*5350 *11,450	*5350 *11,450	*4200 *9,050	4050 8,750	*3700 *8,000	2650 5,650			*2050 *4,500	1900 4,150	7.40 24'2"
1.5 m 5.0 ft	kg lb			*8200 *17,650	6900 14,800	*5300 *11,400	3800 8,150	3700 7,900	2500 5,400	*2400	1800	*2150 *4,750	1800 3,900	7.55 24'9"
0 m 0 ft	kg lb			*7250 *16,750	6450 13,800	5500 11,800	3550 7,700	3550 7,650	2400 5,150			*2400 *5,250	1800 3,900	7.40 24'3"
-1.5 m -5.0 ft	kg lb	*4350 *9,700	*4350 *9,700	*9200 *21,000	6300 13,500	5400 11,550	3450 7,450	3500 7,550	2350 5,050			*2850 *6,250	1950 4,300	6.91 22'7"
-3.0 m -10.0 ft	kg lb	*7450 *16,800	*7450 *16,800	*8800 *19,050	6350 13,650	5400 11,550	3450 7,450	3550	2350			3500 7,800	2350 5,250	6.02 19'7"
-4.5 m -15.0 ft	kg lb			*6400 *13,550	*6400 *13,550							*4000 *8,800	3650 8,300	4.48 14'4"

Reach Boom Lift Capacities – Counterweight: 2470 kg (5,445 lb) – without Bucket – Blade Up

2600 mm (8'6") Blade

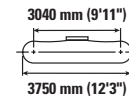

		1.5 m/5.0 ft		3.0 m/10.0 ft		4.5 m/15.0 ft		6.0 m/20.0 ft		7.5 m/25.0 ft				
7.5 m 25.0 ft	kg lb											*2600 *5,850	*2600 *5,850	m ft/in
6.0 m 20.0 ft	kg lb							*2250 *2250	*2250 *2250			*2200 *4,850	*2200 *4,850	6.03 19'6"
4.5 m 15.0 ft	kg lb							*3350 *7,300	2700 5,750			*2050 *4,500	*2050 *4,500	6.92 22'6"
3.0 m 10.0 ft	kg lb			*5350 *11,450	*5350 *11,450	*4200 *9,050	4000 8,650	*3700 *8,000	2600 5,550			*2050 *4,500	1850 4,050	7.40 24'2"
1.5 m 5.0 ft	kg lb			*8200 *17,650	6800 14,650	*5300 *11,400	3750 8,050	3650 7,800	2500 5,300	*2400	1750	*2150 *4,750	1750 3,850	7.55 24'9"
0 m 0 ft	kg lb			*7250 *16,750	6350 13,600	5450 11,650	3550 7,550	3500 7,550	2350 5,100			*2400 *5,250	1750 3,850	7.40 24'3"
-1.5 m -5.0 ft	kg lb	*4350 *9,700	*4350 *9,700	*9200 *21,000	6200 13,350	5300 11,400	3400 7,350	3450 7,400	2300 4,950			*2850 *6,250	1900 4,200	6.91 22'7"
-3.0 m -10.0 ft	kg lb	*7450 *16,800	*7450 *16,800	*8800 *19,050	6250 13,450	5300 11,400	3400 7,350	3500	2350			3450 7,700	2350 5,150	6.02 19'7"
-4.5 m -15.0 ft	kg lb			*6400 *13,550	*6400 *13,550							*4000 *8,800	3600 8,200	4.48 14'4"



ISO 10567:2007



* Indicates that the load is limited by hydraulic lifting capacity rather than tipping load. The above loads are in compliance with hydraulic excavator lift capacity standard ISO 10567:2007. They do not exceed 87% of hydraulic lifting capacity or 75% of tipping load. Weight of all lifting accessories must be deducted from the above lifting capacities. Lifting capacities are based on the machine standing on a firm, uniform supporting surface. The use of a work tool attachment point to handle/lift objects, could affect the machine lift performance.

Lift capacity stays with ±5% for all available track shoes.

Always refer to the appropriate Operation and Maintenance Manual for specific product information.

VISIT SITE NOW >>



VISIT SITE NOW >>

Reach Boom Lift Capacities – Counterweight: 2470 kg (5,445 lb) – without Bucket – Blade Up

2500 mm (8'2") Blade

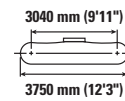
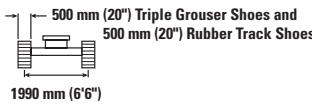
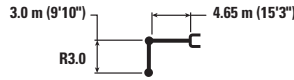

Reach (m/ft)	1.5 m/5.0 ft		3.0 m/10.0 ft		4.5 m/15.0 ft		6.0 m/20.0 ft		7.5 m/25.0 ft		Blade (m/ft)	
	kg/lb	kg/lb	kg/lb	kg/lb	kg/lb	kg/lb	kg/lb	kg/lb	kg/lb	kg/lb	kg/lb	m/ft
7.5 m / 25.0 ft											*2600 / *2600	4.49 / 14'1"
6.0 m / 20.0 ft							*2250 / *2250				*2200 / *2200	6.03 / 19'6"
4.5 m / 15.0 ft							*3350 / *7,300	2650 / 5,600			*2050 / *4,500	6.92 / 22'6"
3.0 m / 10.0 ft			*5350 / *11,450	*5350 / *11,450	*4200 / *9,050	3950 / 8,500	*3700 / 7,950	2550 / 5,450			*2050 / *4,500	7.40 / 24'2"
1.5 m / 5.0 ft			*8200 / *17,650	6650 / 14,350	*5300 / *11,400	3650 / 7,900	3550 / 7,650	2400 / 5,200	*2400 / 1750		*2150 / *4,750	7.55 / 24'9"
0 m / 0 ft			*7250 / *16,750	6200 / 13,300	5350 / 11,450	3450 / 7,400	3450 / 7,400	2300 / 4,950			*2400 / 5,250	7.40 / 24'3"
-1.5 m / -5.0 ft	*4350 / *9,700	*4350 / *9,700	*9200 / *21,000	6100 / 13,050	5200 / 11,200	3350 / 7,200	3400 / 7,300	2250 / 4,850			2800 / 6,100	6.91 / 22'7"
-3.0 m / -10.0 ft	*7450 / *16,800	*7450 / *16,800	*8800 / *19,050	6150 / 13,150	5200 / 11,200	3350 / 7,200	3400 / 7,200	2300 / 2300			3400 / 7,550	6.02 / 19'7"
-4.5 m / -15.0 ft			*6400 / *13,550	6350 / *13,550							*4000 / *8,800	4.48 / 14'4"

Reach Boom Lift Capacities – Counterweight: 2470 kg (5,445 lb) – without Bucket – Blade Up

2500 mm (8'2") Blade

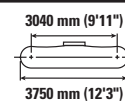

Reach (m/ft)	1.5 m/5.0 ft		3.0 m/10.0 ft		4.5 m/15.0 ft		6.0 m/20.0 ft		7.5 m/25.0 ft		Blade (m/ft)	
	kg/lb	kg/lb	kg/lb	kg/lb	kg/lb	kg/lb	kg/lb	kg/lb	kg/lb	kg/lb	kg/lb	m/ft
7.5 m / 25.0 ft											*2600 / *2600	4.49 / 14'1"
6.0 m / 20.0 ft							*2250 / *2250				*2200 / *2200	6.03 / 19'6"
4.5 m / 15.0 ft							*3350 / *7,300	2700 / 5,750			*2050 / *4,500	6.92 / 22'6"
3.0 m / 10.0 ft			*5350 / *11,450	*5350 / *11,450	*4200 / *9,050	4050 / 8,700	*3700 / *8,000	2600 / 5,600			*2050 / *4,500	7.40 / 24'2"
1.5 m / 5.0 ft			*8200 / *17,650	6850 / 14,700	*5300 / *11,400	3750 / 8,100	3700 / 7,900	2500 / 5,350	*2400 / 1800		*2150 / *4,750	7.55 / 24'9"
0 m / 0 ft			*7250 / *16,750	6350 / 13,700	5500 / 11,800	3550 / 7,600	3550 / 7,650	2400 / 5,100			*2400 / 5,250	7.40 / 24'3"
-1.5 m / -5.0 ft	*4350 / *9,700	*4350 / *9,700	*9200 / *21,000	6250 / 13,400	5350 / 11,500	3450 / 7,400	3500 / 7,500	2350 / 5,000			2850 / 6,250	6.91 / 22'7"
-3.0 m / -10.0 ft	*7450 / *16,800	*7450 / *16,800	*8800 / *19,050	6300 / 13,500	5350 / 11,550	3450 / 7,400	3550 / 7,400	2350 / 2350			3500 / 7,800	6.02 / 19'7"
-4.5 m / -15.0 ft			*6400 / *13,550	6400 / *13,550							*4000 / *8,800	4.48 / 14'4"



ISO 10567:2007



* Indicates that the load is limited by hydraulic lifting capacity rather than tipping load. The above loads are in compliance with hydraulic excavator lift capacity standard ISO 10567:2007. They do not exceed 87% of hydraulic lifting capacity or 75% of tipping load. Weight of all lifting accessories must be deducted from the above lifting capacities. Lifting capacities are based on the machine standing on a firm, uniform supporting surface. The use of a work tool attachment point to handle/lift objects, could affect the machine lift performance.

Lift capacity stays with ±5% for all available track shoes.

Always refer to the appropriate Operation and Maintenance Manual for specific product information.

VISIT SITE NOW >>



Bucket Specifications and Compatibility

		2470 kg (5,445 lb) Counterweight									
		Reach Boom									
		mm	in	m ³	yd ³	kg	lb	%	R2.8 (9'2")	R2.8 (9'2") TRS	R3.0 (9'10")
Pin-On (No Quick Coupler)											
General Duty	312	450	18	0.20	0.27	268	591	100	●	●	●
	312	600	24	0.31	0.40	320	706	100	●	●	●
	312	750	30	0.41	0.54	369	814	100	●	●	●
	312	900	36	0.53	0.69	420	927	100	●	●	●
	312	1050	42	0.65	0.84	468	1,031	100	⊙	⊙	⊙
General Duty – Wide Tip	312	450	18	0.27	0.36	317	700	100	●	●	●
	312	600	24	0.41	0.53	372	821	100	●	●	●
	312	750	30	0.55	0.72	425	936	101	●	●	●
	312	900	36	0.71	0.92	478	1,053	100	⊙	⊙	⊖
	312	1050	42	0.86	1.13	530	1,168	100	○	○	○
Severe Duty	312	600	24	0.31	0.40	372	820	90	●	●	●
	312	750	30	0.41	0.54	433	954	90	●	●	●
	312	900	36	0.53	0.69	495	1,090	90	●	●	●
	312	1050	42	0.65	0.84	540	1,190	90	●	●	⊙
Clean Up	312	1500	60	1.02	1.33	630	1,389	100	◇	◇	◇
Ditch Cleaning	312	1200	48	0.57	0.74	388	855	100	●	●	●
	312	1500	60	0.74	0.97	455	1,003	100	⊙	⊖	⊖
Ditch Cleaning Tilt	312	1200	48	0.48	0.63	563	1,240	100	●	●	●
	312	1500	60	0.57	0.75	646	1,424	100	⊙	⊙	⊙
Maximum load pin-on (payload + bucket)								kg	1750	1720	1680
								lb	3,861	3,791	3,696

The above loads are in compliance with hydraulic excavator standard EN474-5:2006 + A3:2013, they do not exceed 87% of hydraulic lifting capacity or 75% of tipping capacity with front linkage fully extended at ground line with bucket curled.
Capacity based on ISO 7451:2007.

Maximum Material Density:

- 2100 kg/m³ (3,500 lb/yd³)
- ⊙ 1800 kg/m³ (3,000 lb/yd³)
- ⊖ 1500 kg/m³ (2,500 lb/yd³)
- 1200 kg/m³ (2,000 lb/yd³)
- ◇ 900 kg/m³ (1,500 lb/yd³)

Caterpillar recommends using appropriate work tools to maximize the value customers receive from our products. Use of work tools, including buckets, which are outside of Caterpillar's recommendations or specifications for weight, dimensions, flows, pressures, etc. may result in less-than-optimal performance, including but not limited to reductions in production, stability, reliability, and component durability. Improper use of a work tool resulting in sweeping, prying, twisting and/or catching of heavy loads will reduce the life of the boom and stick.

(continued on next page)



Bucket Specifications and Compatibility (continued)

									2470 kg (5,445 lb) Counterweight			
								Reach Boom				
		mm	in	m ³	yd ³	kg	lb	%	R2.8 (9'2")	R2.8 (9'2") TRS	R3.0 (9'10")	
With Cat Pin Grabber Coupler												
General Duty	312	450	18	0.20	0.27	268	591	100	●	●	●	
	312	600	24	0.31	0.40	320	706	100	●	●	●	
	312	750	30	0.41	0.54	369	814	100	●	●	●	
	312	900	36	0.53	0.69	420	927	100	●	●	⊙	
	312	1050	42	0.65	0.84	468	1,031	100	⊖	⊖	⊖	
	312	1200	48	0.76	1.00	508	1,119	100	○	○	○	
General Duty – Wide Tip	312	450	18	0.27	0.36	317	700	100	●	●	●	
	312	600	24	0.41	0.53	372	821	100	●	●	●	
	312	750	30	0.55	0.72	425	936	101	●	⊙	⊙	
	312	900	36	0.71	0.92	478	1,053	100	⊖	⊖	○	
	312	1050	42	0.86	1.13	530	1,168	100	○	○	◇	
	312	1200	48	1.02	1.33	582	1,283	100	◇	◇	◇	
Severe Duty	312	600	24	0.31	0.40	372	820	90	●	●	●	
	312	750	30	0.41	0.54	433	954	90	●	●	●	
	312	900	36	0.53	0.69	495	1,090	90	●	●	●	
	312	1050	42	0.65	0.84	540	1,190	90	⊙	⊖	⊖	
Clean Up	312	1500	60	1.02	1.33	630	1,389	100	◇	◇	X	
Ditch Cleaning	312	1200	48	0.57	0.74	388	855	100	●	⊙	⊙	
	312	1500	60	0.74	0.97	455	1,003	100	⊖	⊖	○	
Ditch Cleaning Tilt	312	1200	48	0.48	0.63	563	1,240	100	●	⊙	⊙	
	312	1500	60	0.57	0.75	646	1,424	100	⊖	⊖	⊖	
Maximum load with coupler (payload + bucket)								kg	1551	1520	1477	
								lb	3,420	3,350	3,256	

The above loads are in compliance with hydraulic excavator standard EN474-5:2006 + A3:2013, they do not exceed 87% of hydraulic lifting capacity or 75% of tipping capacity with front linkage fully extended at ground line with bucket curled.
Capacity based on ISO 7451:2007.

Maximum Material Density:

- 2100 kg/m³ (3,500 lb/yd³)
- ⊙ 1800 kg/m³ (3,000 lb/yd³)
- ⊖ 1500 kg/m³ (2,500 lb/yd³)
- 1200 kg/m³ (2,000 lb/yd³)
- ◇ 900 kg/m³ (1,500 lb/yd³)

Caterpillar recommends using appropriate work tools to maximize the value customers receive from our products. Use of work tools, including buckets, which are outside of Caterpillar's recommendations or specifications for weight, dimensions, flows, pressures, etc. may result in less-than-optimal performance, including but not limited to reductions in production, stability, reliability, and component durability. Improper use of a work tool resulting in sweeping, prying, twisting and/or catching of heavy loads will reduce the life of the boom and stick.

(continued on next page)



VISIT SITE NOW »

Attachments Offering Guide

Not all Attachments are available in all regions. Consult your Cat dealer for configurations available in your region.

Match

* Working range front only

No Match

PIN-ON ATTACHMENTS

Boom Type	Stick Length	Reach		
		2.80 m (9'2")	2.80 m TR (9'2")	3.00 m (9'10")
Hydraulic Hammers	H110 GC	✓	✓	✓
	H110 GC S	✓	✓	✓
	H110 S	✓	✓	✓
	H115 GC	✓	✓	✓
	H115 GC S	✓	✓	✓
	H115 S	✓	✓	✓
Demolition and Sorting Grapples	G314	✓*	✓*	✓*
Mobile Scrap and Demolition Shears	S3015 Flat Top	✓*	✓*	✓*
Compactors (Vibratory Plate)	CVP75	✓	✓	✓
Mulchers	HM2615	✓	✓	✓
	HM3013	✓	✓	✓

CAT PIN GRABBER COUPLER ATTACHMENTS

Boom Type	Stick Length	Reach		
		2.80 m (9'2")	2.80 m TR (9'2")	3.00 m (9'10")
Hydraulic Hammers	H110 GC	✓	✓	✓
	H110 GC S	✓	✓	✓
	H110 S	✓	✓	✓
	H115 GC	✓*	✓*	
	H115 GC S	✓	✓*	✓*
	H115 S	✓	✓	✓
Compactors (Vibratory Plate)	CVP75	✓	✓	✓
Mulchers	HM2615	✓	✓	✓
	HM3013	✓	✓	

S60 DEDICATED COUPLER ATTACHMENTS

Boom Type	Stick Length	Reach		
		2.20 m (7'3")	2.50 m (8'2")	3.00 m (9'10")
Hydraulic Hammers	H110 GC	✓	✓	✓
	H110 GC S	✓	✓	✓
	H110 S	✓	✓	✓
	H115 GC	✓	✓*	✓*
	H115 GC S	✓	✓*	✓*
	H115 S	✓	✓	✓
Compactors (Vibratory Plate)	CVP75	✓	✓	✓

HCS60 DEDICATED COUPLER ATTACHMENTS

Boom Type	Stick Length	Reach		
		2.20 m (7'3")	2.50 m (8'2")	3.00 m (9'10")
Hydraulic Hammers	H110 S	✓	✓	✓
	H115 S	✓	✓	✓
Compactors (Vibratory Plate)	CVP75	✓	✓	✓

(continued on next page)

VISIT SITE NOW »



[VISIT SITE NOW >>](#)

ATTACHMENTS OFFERING GUIDE

Not all Attachments are available in all regions. Consult your Cat dealer for configurations available in your region.

Match

* Working range front only

No Match

HCS65 DEDICATED COUPLER ATTACHMENTS

Boom Type		Reach		
		2.20 m (7'3")	2.50 m (8'2")	3.00 m (9'10")
Hydraulic Hammers	H110 S	✓	✓	✓
	H115 S	✓	✓	✓
Compactors (Vibratory Plate)	CVP75	✓	✓	✓

TRS10 (PIN-ON TOP / S60 BOTTOM) ATTACHMENTS

Some attachments require more hydraulic flow and are best suited with a machine that has HP2 circuits and a tiltrotator with a high flow swivel. Check the hydraulic capability of your machine and tiltrotator and the requirements of your attachment to ensure a proper match.

Boom Type		Reach		
		2.20 m (7'3")	2.50 m (8'2")	3.00 m (9'10")
Hydraulic Hammers	H110 GC S	✓*	✓*	✓*
	H110 S	✓	✓	✓*
Compactors (Vibratory Plate)	CVP75	✓	✓	✓

NOTE: Use hammers on tiltrotators less than 10% of working hours per year or maximum 200 hours per year. Refer to your Operation and Maintenance Manual for recommended hydraulic flow requirements.

TRS10 (S60 TOP / S60 BOTTOM) ATTACHMENTS

Some attachments require more hydraulic flow and are best suited with a machine that has HP2 circuits and a tiltrotator with a high flow swivel. Check the hydraulic capability of your machine and tiltrotator and the requirements of your attachment to ensure a proper match.

Boom Type		Reach		
		2.20 m (7'3")	2.50 m (8'2")	3.00 m (9'10")
Compactors (Vibratory Plate)	CVP75	✓*	✓*	✓*

TRS10 (PIN-ON TOP / HCS60 BOTTOM) ATTACHMENTS

Some attachments require more hydraulic flow and are best suited with a machine that has HP2 circuits and a tiltrotator with a high flow swivel. Check the hydraulic capability of your machine and tiltrotator and the requirements of your attachment to ensure a proper match.

Boom Type		Reach		
		2.20 m (7'3")	2.50 m (8'2")	3.00 m (9'10")
Hydraulic Hammers	H110 S	✓*		
Compactors (Vibratory Plate)	CVP75	✓	✓	✓

NOTE: Use hammers on tiltrotators less than 10% of working hours per year or maximum 200 hours per year. Refer to your Operation and Maintenance Manual for recommended hydraulic flow requirements.

BOOM-MOUNT ATTACHMENTS

Boom Type		Reach
Mobile Scrap and Demolition Shears	S3025 Flat Top	✓

[VISIT SITE NOW >>](#)



[VISIT SITE NOW »](#)

Thumb Specifications

Match No Match

	Tooth Quantity	Width		Pro Plus		Pro		Stiff Link		Utility	
		mm	in	Pin-on	Cat Pin Grabber	Pin-on	Cat Pin Grabber	Pin-on	Cat Pin Grabber	Pin-on	Cat Pin Grabber
Bucket Type											
General Duty	3	450	18					✓	✓	✓	✓
	4	600	24		✓		✓	✓	✓	✓	✓
	5	750	30	✓	✓	✓	✓	✓	✓	✓	✓
	6	900	36	✓	✓	✓	✓	✓	✓	✓	✓
	7	1050	42	✓	✓	✓	✓	✓	✓	✓	✓
	7	1200	48	✓	✓	✓	✓	✓	✓	✓	✓
General Duty - Wide Tip	4	450	18					✓	✓	✓	✓
	5	600	24					✓	✓	✓	✓
	7	900	36					✓	✓	✓	✓
	8	1074	42					✓	✓	✓	✓
	9	1226	48					✓	✓	✓	✓
Severe Duty	3	600	24		✓		✓	✓	✓	✓	✓
	4	750	30	✓	✓	✓	✓	✓	✓	✓	✓
	5	900	36	✓	✓	✓	✓	✓	✓	✓	✓
	5	1050	42	✓	✓	✓	✓	✓	✓	✓	✓

[VISIT SITE NOW »](#)



VISIT SITE NOW »

Standard and Optional Equipment

Standard and optional equipment may vary. Consult your Cat dealer for details.

	Standard	Optional
BOOMS, STICKS AND LINKAGES		
4.65 m (15'3") Reach boom	✓	
2.8 m (9'2") Reach stick		✓
2.8 m (9'2") Thumb Ready stick		✓
3.0 m (9'10") Reach stick		✓
Bucket linkage, without lifting eye, Cat Grade	✓	
CAB		
ROPS	✓	
High-resolution 254 mm (10") LCD touchscreen monitor	✓	
Auto bi-level air conditioner	✓	
Jog dial and shortcut keys for monitor control	✓	
Keyless push-to-start engine control	✓	
Height-adjustable console	✓	
Tilt-up left-side console	✓	
Heated air-suspension seat	✓	
51 mm (2") seat belt	✓	
Monitor integrated Bluetooth® radio with USB/Auxiliary ports	✓	
12V DC outlets	✓	
Document storage	✓	
Overhead storage and rear storage with nets	✓	
Beverage holder	✓	
Cup holder	✓	
Openable two-piece front window	✓	
Rear window emergency exit	✓	
Radial wiper with washer	✓	
Openable polycarbonate skylight hatch	✓	
LED dome light	✓	
Floor welcome light	✓	
Roof sunscreen	✓	
Roller front sunscreen	✓	
Roller rear sunscreen		✓
Washable floor mat	✓	
Beacon ready	✓	
Cat Stick Steer		✓
Auxiliary relay		✓
Operator protective guards (OPG)		✓

* Connect subscription only. Additional subscriptions are available. Contact your Cat dealer for availability.

	Standard	Optional
CAT TECHNOLOGY		
VisionLink®	✓*	
VisionLink Productivity		✓
Remote Flash	✓	
Remote Troubleshoot	✓	
Cat Grade Connectivity		✓
Compatibility with radios and base stations from Trimble, Topcon, and Leica	✓	
Capability to install 3D grade systems from Trimble, Topcon, and Leica	✓	
Cat Grade 2D	✓	
Cat Grade 2D with Attachment Ready Option (ARO)		✓
Cat Grade 3D single GNSS		✓
Cat Grade 3D dual GNSS		✓
Laser catcher		✓
Cat Assist:	✓	
– Grade Assist		
– Boom Assist		
– Bucket Assist		
– Swing Assist		
– Lift Assist		
Cat Payload:	✓	
– Static weigh		
– Semiautomatic calibration		
– Payload/cycle information		
– USB reporting capability		
Work tool recognition (PL161)	✓	
Work tool tracking (PL161)	✓	
Cat Tilt Rotator (TRS) Integration		✓
Operator Coaching		✓

ELECTRICAL SYSTEM		
Maintenance free battery	✓	
Centralized electrical disconnect switch	✓	
LED chassis light, left-side/right-side boom light, cab lights	✓	
Programmable time-delay LED working lights	✓	
360° lighting		✓

(continued on next page)

VISIT SITE NOW »



VISIT SITE NOW »

Standard and Optional Equipment (continued)

Standard and optional equipment may vary. Consult your Cat dealer for details.

	Standard	Optional
ENGINE		
Cat® C3.6 single turbo diesel engine	✓	
Three selectable modes: Power, Smart, Eco	✓	
One-touch low idle with automatic engine speed control	✓	
Auto engine shutdown	✓	
52° C (125° F) high-ambient cooling capacity without derate	✓	
-25° C (-13° F) cold start capability		✓
-18° C (-0° F) cold start capability		✓
Electric fuel priming pump	✓	
Variable speed fan	✓	
Single fuel filtration system	✓	
Sealed double element air filter with integrated pre-cleaner	✓	
HYDRAULIC SYSTEM		
Boom and stick regeneration circuits	✓	
Automatic hydraulic oil warm up	✓	
Automatic two-speed travel	✓	
Electric main control valve	✓	
Boom and stick drift reduction valve	✓	
Swing drive, with fine swing control function	✓	
Boom and stick lowering check valves		✓
Medium-pressure line		✓
High-pressure line		✓
Quick coupler line		✓
SAFETY AND SECURITY		
Cat Detect - People detection		✓
Rear and right-side-view cameras		✓
360° visibility		✓
Ground level engine shutoff switch	✓	
Lockable disconnect switch	✓	
Service platform with anti-skid plate and countersunk bolts	✓	
Signaling/warning horn	✓	

	Standard	Optional
Swing alarm		✓
Hydraulic lock out lever	✓	
Inspection lighting		✓
Cat Command remote control		✓
2D E-Fence:	✓	
- E-ceiling		
- E-floor		
- E-swing		
- E-wall		
- E-cab avoidance		
Auto hammer stop	✓	
SERVICE AND MAINTENANCE		
Side entry to service platform	✓	
Grouped engine oil and fuel filters	✓	
Ground level engine oil dipstick	✓	
Scheduled Oil Sampling (S-O-S SM) ports	✓	
Integrated vehicle health management system	✓	
UNDERCARRIAGE AND STRUCTURES		
Grease lubricated track link	✓	
Center track guiding guards	✓	
Bottom guards	✓	
HD travel motor guards	✓	
Swivel guard	✓	
500 mm (20") triple grouser track shoes		✓
500 mm (20") triple grouser track shoes with rubber pad		✓
500 mm (20") rubber track shoes		✓
600 mm (24") triple grouser track shoes		✓
600 mm (24") rubber track shoes		✓
700 mm (28") triple grouser track shoes		✓
2500 mm (8'2") blade		✓
2600 mm (8'6") blade		✓
2700 mm (8'10") blade		✓
2470 kg (5,445 lb) counterweight	✓	
Tie-down points on base frame	✓	

VISIT SITE NOW »



HAWK

Reach Beyond, with HAWK.

[VISIT SITE NOW >>](#)

Dealer Installed Kits and Attachments

Attachments may vary. Consult your Cat dealer for details.

CAB

- Radial lower wiper
- Left-hand and right-hand electrical pedal (two-way) for tool control
- Dual exit rear window kit
- Rain protector plus cab light cover
- Front windshield laminated glass (P5A glass, EU demolition regulation)
- Key fob (for use with Bluetooth receiver)

GUARDS

- Operator Protective Guards (OPG) (not compatible with cab light cover, rain protector)
- Mesh guard full front (not compatible with cab light cover, rain protector)
- Mesh guard lower half front
- Full protecting vandalism guard

SAFETY AND SECURITY

- 76 mm (3") retractable seat belt

[VISIT SITE NOW >>](#)



VISIT SITE NOW >>

313 ENVIRONMENTAL DECLARATION

The following information applies to the machine at the time of final manufacture as configured for sale in the regions covered in this document. The content of this declaration is valid as of the date issued; however, content related to machine features and specifications are subject to change without notice. For additional information, please see the machine's Operation and Maintenance Manual.

For more information on sustainability in action and our progress, please visit <https://www.caterpillar.com/en/company/sustainability>.

Engine

- The Cat® C3.6 engine meets U.S. EPA Tier 4 Final, EU Stage V, and Japan 2014 emission standards.
- Cat diesel engines are required to use ULSD (ultra-low sulfur diesel fuel with 15 ppm of sulfur or less) or ULSD blended with the following lower-carbon intensity fuels** up to:
 - ✓ 20% biodiesel FAME (fatty acid methyl ester)*
 - ✓ 100% renewable diesel, HVO (hydrotreated vegetable oil) and GTL (gas-to-liquid) fuels

Refer to guidelines for successful application. Please consult your Cat dealer or "Caterpillar Machine Fluids Recommendations" (SEBU6250) for details.

**Engines with no aftertreatment devices can use higher blends, up to 100% biodiesel (for use of blends higher than 20% biodiesel, consult your Cat dealer).*

*** Tailpipe greenhouse gas emissions from lower-carbon intensity fuels are essentially the same as traditional fuels.*

Air Conditioning System

- The air conditioning system on this machine contains the fluorinated greenhouse gas refrigerant R134a (Global Warming Potential = 1430). The system contains 0.85 kg (1.9 lb) of refrigerant which has a CO₂ equivalent of 1.216 metric tonnes (1.340 tons).

Paint

- Based on best available knowledge, the maximum allowable concentration, measured in parts per million (PPM), of the following heavy metals in paint are:
 - Barium < 0.01%
 - Cadmium < 0.01%
 - Chromium < 0.01%
 - Lead < 0.01%

Sound Performance

ISO 6395:2008 (external)	100 dB(A)
ISO 6396:2008 (inside cab)	68 dB(A)

- Hearing protection may be needed when operating with an open operator station and cab (when not properly maintained or doors/windows open) for extended periods or in a noisy environment.

Oils and Fluids

- Caterpillar factory fills with ethylene glycol coolants. Cat Diesel Engine Antifreeze/Coolant (DEAC) and Cat Extended Life Coolant (ELC) can be recycled. Consult your Cat dealer for more information.
- Cat Bio HYDO™ Advanced is an EU Ecolabel approved biodegradable hydraulic oil.
- Additional fluids are likely to be present, please consult the Operations and Maintenance Manual or the Application and Installation guide for complete fluid recommendations and maintenance intervals.

Features and Technology

- The 313 is up to 10% more fuel efficient than the 313F. The following features and technology may contribute to fuel savings and/or carbon reduction. Features may vary. Consult your Cat dealer for details.
 - Advanced hydraulic system balances power and efficiency
 - Smart mode matches machine power to digging requirements automatically
 - Eco mode minimizes fuel consumption for light applications
 - One-touch low idle with automatic engine speed control
 - Cat Grade with 2D improves operator efficiency by up to 45%
 - Cut maintenance costs up to 25% with extended and synchronized intervals
 - Remote Flash and Remote Troubleshoot

Recycling

- The materials included in machines are categorized as below with approximate weight percentage. Because of variations of product configurations, the following values in the table may vary.

Material Type	Weight Percentage
Steel	80.28%
Iron	4.22%
Nonferrous Metal	2.85%
Mixed Metal	0.34%
Mixed-Metal and Nonmetal	2.73%
Plastic	0.08%
Rubber	4.25%
Mixed Nonmetallic	1.05%
Fluid	2.79%
Other	1.41%
Uncategorized	0.00%
Total	100%

VISIT SITE NOW >>



[VISIT SITE NOW >>](#)

Recycling

A machine with higher recyclability rate will ensure more efficient usage of valuable natural resources and enhance End-of-Life value of the product. According to ISO 16714:2008 (Earthmoving machinery – Recyclability and recoverability – Terminology and calculation method), recyclability rate is defined as percentage by mass (mass fraction in percent) of the new machine potentially able to be recycled, reused or both.

All parts in the bill of material are first evaluated by component type based on a list of components defined by the ISO 16714:2008 and Japan CEMA (Construction Equipment Manufacturers Association) standards. Remaining parts are further evaluated for recyclability based on material type.

Because of variations of product configurations, the following value in the table may vary.

Recyclability – 95%

[VISIT SITE NOW >>](#)